



# LiteBeam<sup>®</sup>

5 GHz, 23 dBi airMAX<sup>®</sup> CPE  
with InnerFeed Technology

Models: LBE-M5-23, LBE-5AC-23

Lightweight, Low-Cost Solution

Full Adjustment Flexibility

Quick Assembly and Installation



# LiteBeam®

The LiteBeam® is the latest evolution of a lightweight and compact, outdoor wireless broadband product from Ubiquiti Networks. Each of these models was designed to be an affordable cost/performance solution for long-distance, wireless broadband bridging. It operates in the worldwide, license-free 5 GHz frequency range with high-performance speeds.

The LiteBeam combines proprietary hardware and software technologies to deliver its breakthrough combination of throughput and range with cost-effective value.

The InnerFeed® technology integrates the entire radio system into the antenna feed, and our revolutionary airMAX TDMA protocol enhances network performance and scalability.

## Integrated airMAX Technology

Unlike standard Wi-Fi protocol, the exclusive Ubiquiti Networks® airMAX Time Division Multiple Access (TDMA) protocol allows each client to send and receive data using pre-designated time slots managed by an intelligent AP controller. This "time slot" method eliminates hidden node collisions and maximizes airtime efficiency.

Compared to other systems in its class, the LiteBeam products deliver superior performance in reduced latency, throughput, and scalability.

- **Intelligent QoS** Priority is given to voice/video for seamless access.
- **Scalability** High capacity and scalability.
- **Long Distance** Capable of high-speed, 30+ km links.

## Application Examples

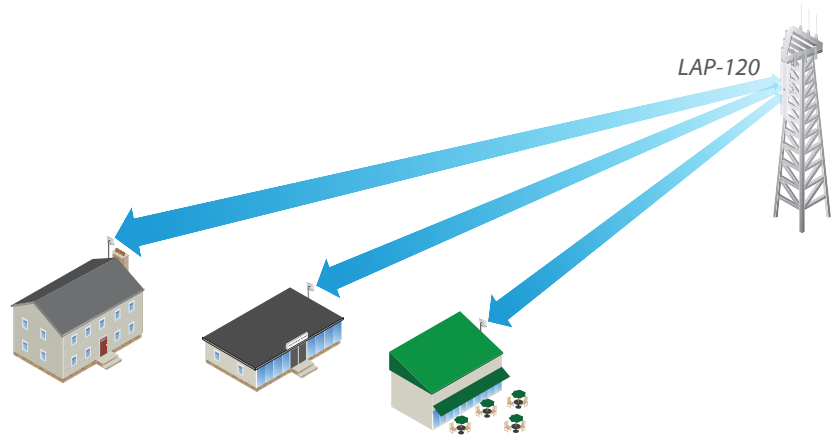

*In a cost-effective WISP deployment, the LiteBeam acts as a CPE in an airMAX Point-to-Multipoint network.*

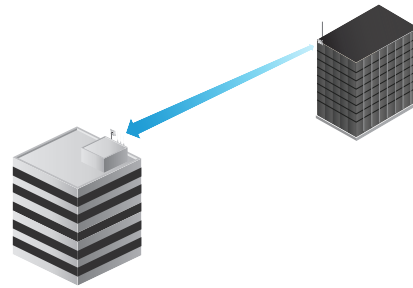

*A LiteBeam on each side of a Point-to-Point link.*

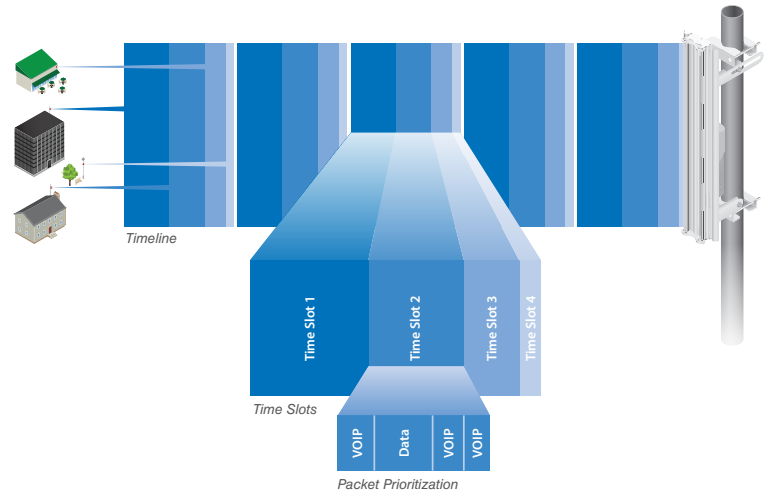

*Up to 100 airMAX stations can be connected to an airMAX Sector; four airMAX stations are shown to illustrate the general concept.*

# Hardware Overview

## Full Adjustment Flexibility

The LiteBeam features a unique ball joint mount that provides adjustment flexibility along three axes for versatile mounting options. The mounting system, coupled with the built-in bubble level, enables quick and easy alignment.

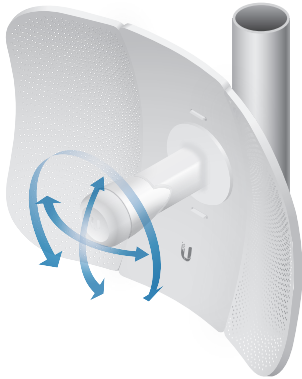

LBE-5AC-23

## Quick, Snap-and-Lock Assembly

The all-new mechanical design makes assembling the LiteBeam – literally – a snap. No tools are required. Simply snap the feed, antenna panels, rear housing, and ball joint mount together for a secure, solid assembly.

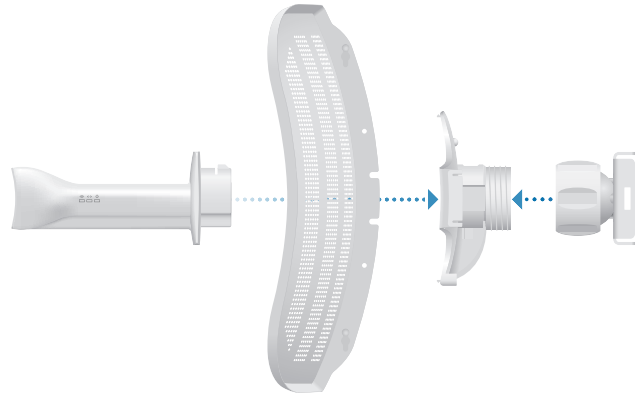

LBE-M5-23

## Model Comparison

	LBE-M5-23	LBE-5AC-23
Frequency Band	5 GHz	5 GHz
Antenna Gain	23 dBi	23 dBi
Antenna Type	1x1 SISO	2x2 MIMO
Polarization	Vertical	Vertical + Horizontal
airMAX ac		✓
Gigabit Ethernet		✓
Point-to-Point Functionality	✓	✓

## SISO Versus MIMO Functionality

LiteBeam® M5



LiteBeam® ac

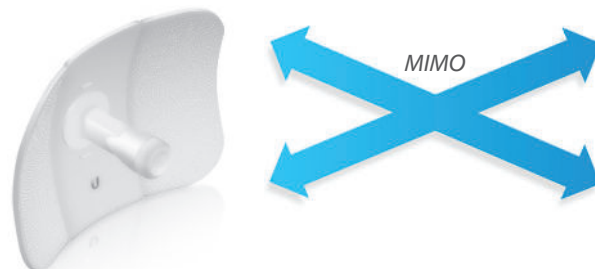

# LBE-M5-23 Specifications

LBE-M5-23	
Dimensions (No Mount)	362 x 267 x 184 mm (14.25 x 10.51 x 7.24")
Weight (No Mount)	750 g (24.11 oz)
Mounting Kit	Pole Mounting Kit (Included)
Networking Interface	(1) 10/100 Ethernet Port
Memory	64 MB
Max. Power Consumption	4W
Max. TX Power	25 dBm
Antenna Gain	23 dBi
Operating Frequency	Worldwide: 5150 - 5875 MHz USA: 5150 - 5850 MHz
Power Supply	24V, 0.2A PoE Adapter (Included)
Power Method	Passive PoE (Pairs 4, 5+; 7, 8 Return)
Processor Specs	Atheros MIPS 74Kc, 533 MHz
Operating Temperature	-40 to 70° C (-40 to 158° F)
Operating Humidity	5 to 95% Noncondensing
Shock and Vibration	ETSI300-019-1.4
ETSI Specification	EN 302 326 DN2
ESD/EMP Protection	± 24 kV Contact / Air
Certifications	FCC, IC, CE

Output Power: 25 dBm							
TX Power Specifications				RX Power Specifications			
Modulation	Data Rate	Avg. TX	Tolerance	Modulation	Data Rate	Sensitivity	Tolerance
<b>802.11n/airMAX</b>	MCS0	25 dBm	± 2 dB	<b>802.11n/airMAX</b>	MCS0	-97 dBm	± 2 dB
	MCS1	25 dBm	± 2 dB		MCS1	-96 dBm	± 2 dB
	MCS2	25 dBm	± 2 dB		MCS2	-93 dBm	± 2 dB
	MCS3	24 dBm	± 2 dB		MCS3	-91 dBm	± 2 dB
	MCS4	23 dBm	± 2 dB		MCS4	-87 dBm	± 2 dB
	MCS5	22 dBm	± 2 dB		MCS5	-84 dBm	± 2 dB
	MCS6	21 dBm	± 2 dB		MCS6	-78 dBm	± 2 dB
	MCS7	19 dBm	± 2 dB		MCS7	-75 dBm	± 2 dB

Vertical Azimuth

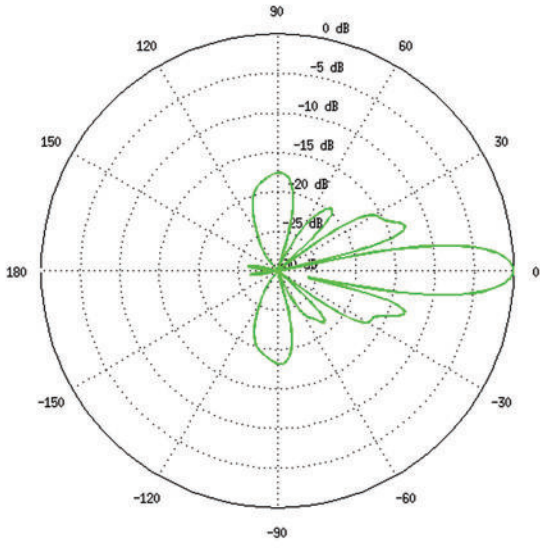

Vertical Elevation

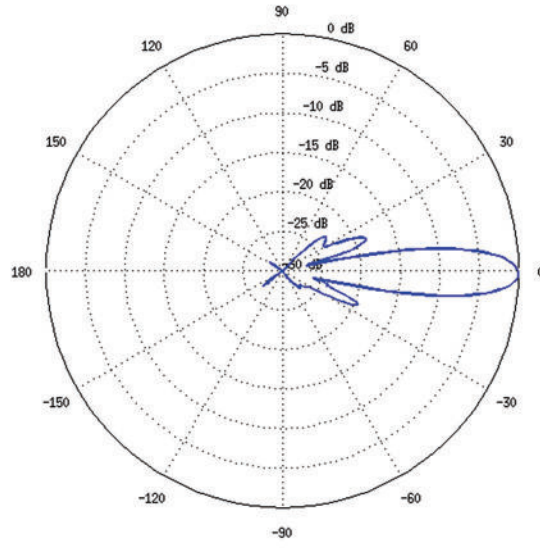

# LBE-5AC-23 Specifications

LBE-5AC-23	
Dimensions (No Mount)	362 x 273 x 203 mm (14.25 x 10.75 x 7.99")
Weight (No Mount)	907 g (2.00 lbs)
Mounting Kit	Pole Mounting Kit (Included)
Networking Interface	(1) 10/100/1000 Ethernet Port
Memory	64 MB
Max. Power Consumption	7W
Max. TX Power	24 dBm
Antenna Gain	23 dBi
Operating Frequency	Worldwide: 5150 - 5875 MHz USA: 5150 - 5850 MHz
Power Supply	24V, 0.3A Gigabit PoE Adapter (Included)
Power Method	Passive PoE (Pairs 4, 5+; 7, 8 Return)
Processor Specs	Atheros MIPS 74Kc, 533 MHz
Operating Temperature	-40 to 70° C (-40 to 158° F)
Operating Humidity	5 to 95% Noncondensing
Shock and Vibration	ETSI300-019-1.4
ETSI Specification	EN 302 326 DN2
ESD/EMP Protection	± 24 kV Contact / Air
Certifications	FCC, IC, CE

Output Power: 24 dBm							
TX Power Specifications				RX Power Specifications			
Modulation	Data Rate	Avg. TX	Tolerance	Modulation	Data Rate	Sensitivity	Tolerance
<b>airMAX ac</b>	1x BPSK (1/2)	24 dBm	± 2 dB	<b>airMAX ac</b>	1x BPSK (1/2)	-96 dBm	± 2 dB
	2x QPSK (1/2)	24 dBm	± 2 dB		2x QPSK (1/2)	-95 dBm	± 2 dB
	2x QPSK (3/4)	24 dBm	± 2 dB		2x QPSK (3/4)	-92 dBm	± 2 dB
	4x 16QAM (1/2)	24 dBm	± 2 dB		4x 16QAM (1/2)	-90 dBm	± 2 dB
	4x 16QAM (3/4)	24 dBm	± 2 dB		4x 16QAM (3/4)	-86 dBm	± 2 dB
	6x 64QAM (2/3)	23 dBm	± 2 dB		6x 64QAM (2/3)	-83 dBm	± 2 dB
	6x 64QAM (3/4)	22 dBm	± 2 dB		6x 64QAM (3/4)	-77 dBm	± 2 dB
	6x 64QAM (5/6)	21 dBm	± 2 dB		6x 64QAM (5/6)	-74 dBm	± 2 dB
	8x 256QAM (3/4)	20 dBm	± 2 dB		8x 256QAM (3/4)	-69 dBm	± 2 dB
	8x 256QAM (5/6)	19 dBm	± 2 dB		8x 256QAM (5/6)	-65 dBm	± 2 dB

Vertical Azimuth

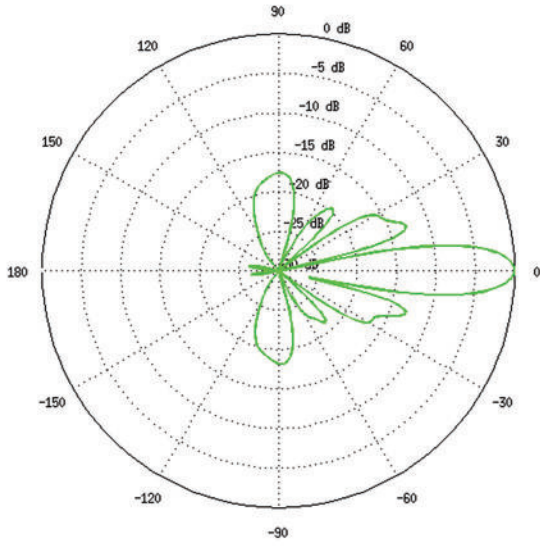

Vertical Elevation

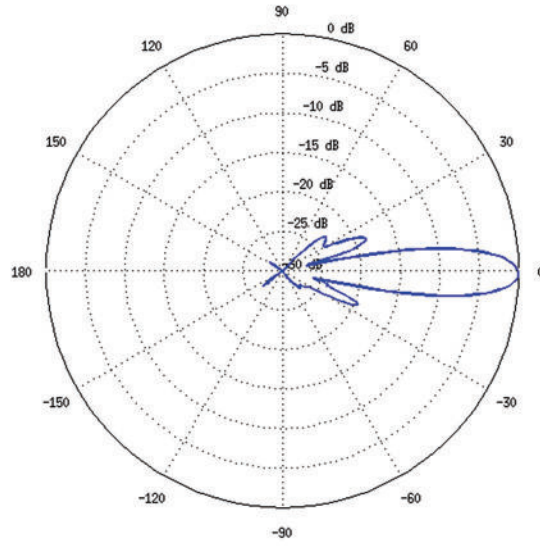

Horizontal Azimuth

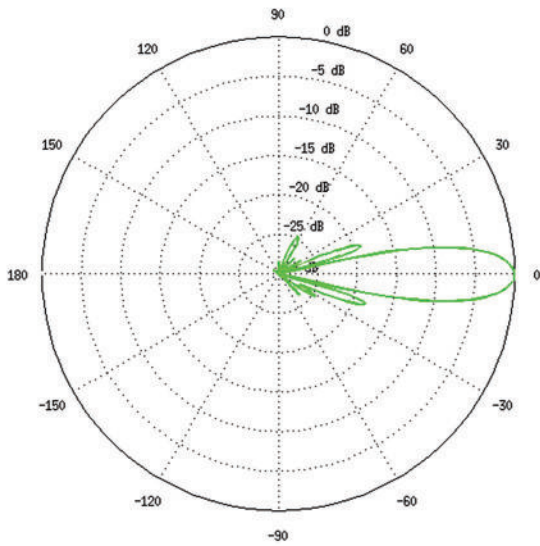

Horizontal Elevation

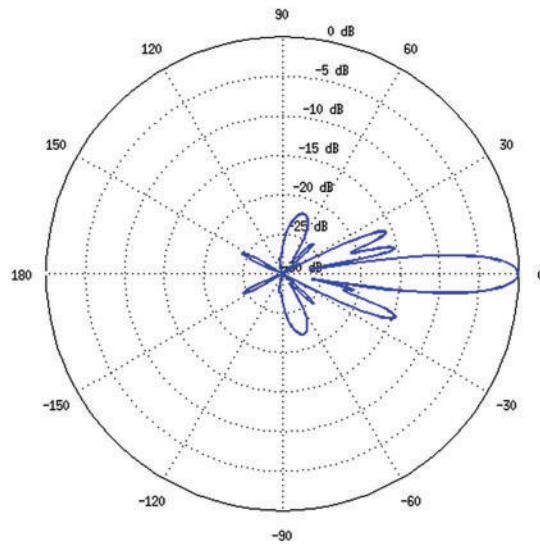

Specifications are subject to change. Ubiquiti products are sold with a limited warranty described at: [www.ubnt.com/support/warranty](http://www.ubnt.com/support/warranty)  
 ©2015-2018 Ubiquiti Networks, Inc. All rights reserved. Ubiquiti, Ubiquiti Networks, the Ubiquiti U logo, the Ubiquiti beam logo, airMAX, airOS, InnerFeed, LiteAP, and LiteBeam are trademarks or registered trademarks of Ubiquiti Networks, Inc. in the United States and in other countries. All other trademarks are the property of their respective owners.